

Ø22 mm系列

按钮及指示灯

产品目录



Ø22 mm系列 按钮及指示灯

XB2B金属系列	按钮				带灯按钮
					
	平头按钮 XB2BA●●C 带1常开或1常闭触点 第5页	带功能符号平头按钮 XB2BA●●●●C 带1常开或1常闭触点 第6页	带罩按钮 XB2BP●●C 带1常开或1常闭触点 第5页	蘑菇头按钮, Ø40mm XB2BC●●C 带1常开或1常闭触点 第5页	交直流24V或交流220V, 含LED XB2BW●●●●C 带1常开触点 第8页
	急停按钮	选择开关		钥匙开关	
					
	旋转复位, 红色 XB2BS●●●C 带1常闭触点 第6页	拉拔复位, 红色 XB2BT(X)●●C 带1常闭触点 第6页	标准手柄 2或3位置, 保持或自动回中心位 XB2BD●●C , 带1常开或2常开或1常闭触点 第7页	长手柄 2或3位置, 保持或自动回中心位 XB2BJ●●C , 带1常开或2常开或1常闭触点 第7页	2或3位置, 保持或自动回中心位 XB2BG●●C , 带1常开或2常开或1常闭触点 第7页
XB5A塑料系列 (模块式)	急停按钮	按钮	选择开关	钥匙开关	带灯按钮
					
	旋转复位, 红色 XB5AS●●●C 带1常闭触点 第20页	平头按钮 XB5AA●●C 带1常开或1常闭触点 第20页	2或3位置, 保持 XB5AD●●C 带1常开或2常开触点 第20页	2或3位置, 保持 XB5AG●●C 带1常开或2常开触点 第20页	交直流24V, 交流110V 交流220V或交流380V XB5AW●●●●C 带1常开触点 第21页
XB7E塑料系列 (一体式)	按钮				
					
	一体式平头按钮 XB7EA●●C 带1常开或2常开或1C/O触点 第26页				
指示灯和蜂鸣器	通用型指示灯	优化型指示灯	蜂鸣器		
					
交直流24V, 交直流48V 直流110V, 交流110V 直流220V, 交流220V 交流380V, 含LED XB2BV●●●LC 第17页	交直流24V 直流110V, 交流110V 直流220V, 交流220V 交流380V, 含LED XB7EV●●●C 第27页	交直流24V 交流110V, 交流220V 持续声音, 灰色 XB2BS●C 第17页			

XB2B 金属系列按钮 Ø22 mm

特性

环境

符合标准	IEC 60947-5-1, EN 60 947-5-1, GB/T 14048.1-93, GB/14048.5-93
防护处理	标准版本: “TC” 和 “TH”
环境温度	工作温度: - 25 ~ +70 °C, 贮存温度: - 40 ~ +70 °C
抗振性	蘑菇头按钮: 8 g, 其它按钮及指示灯: 15 g (40 Hz < 频率 < 500 Hz), 符合IEC 68-2-6
抗冲击	按钮: 70 g, 蘑菇头按钮: 15 g, 选择开关: 200 g, 符合 IEC 68-2-27
电子冲击保护	I 级, 符合 IEC 536 和 NF C 20-030
防护等级	IP65: 平头及凸头, 带或不带指示灯, 按钮 (安装)
符合 IEC 529 和 NF C 20-010	IP66: 带罩按钮
机械寿命	按钮: 3 百万次操作, “紧急停止” 按钮: 30 万次操作

触点特性

额定工作特性	\sim AC-15: A600 或 $U_e = 240\text{ V}$ 和 $I_e = 3\text{ A}$ --- DC-13: Q600 或 $U_e = 250\text{ V}$ 和 $I_e = 0.27\text{ A}$ 符合 IEC 947-5-1 附录 A
额定绝缘电压	$U_i = 600\text{ V}$, 污染等级 3, 符合 IEC 60947-1, $U_i = 600\text{ V}$
额定耐冲击电压	$U_{imp} = 6\text{ kV}$ 符合 IEC 947-1
触头动作	慢断 (常闭或常开), 常闭触点为肯定断开
可靠工作	安全装置 (蘑菇头 “急停” 按钮): 常闭触点分断可靠, 符合 IEC 60947-5-1 第 3 部分
操作压力	平头和凸头按钮 - 带 1 常开触点: 1 daN - 带 1 常闭触点: 0.8 daN 辅助触点 - 常开: + 0.5 daN - 常闭: + 0.3 daN
端子型号	符合 CENELEC EN 50013
短路保护	10 A 熔芯类型 gI 符合 IEC 269-1, VDE 0660-200
额定工作功率	符合 IEC 60947-5-1 附录 C. 应用范围 AC-15 和 DC-13. 操作频率: 3600 次操作/小时。 负载因数: 0.5

交流电源 \sim 50-60 Hz
 ∞ 感性电路

直流电源 ---
 开断功率 W
 操作一百万次

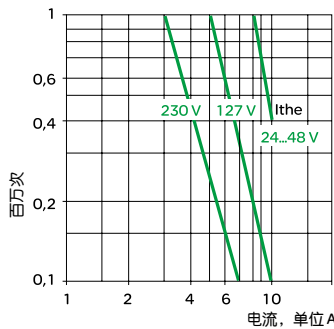

V	24	48	120
W	65	48	40

可靠性能	一亿次操作中, 故障率 < 1 (可编程控制器输入, 24 V d.c.)
接线	- 螺旋压入式端子, 接线能力: 最小 $1 \times 0.5\text{ mm}^2$, 最大, 带或不带接线端片: $2 \times 1.5\text{ mm}^2$ 或 $1 \times 2.5\text{ mm}^2$ - 6.3 mm Faston 端子 (根据需要)

XB2B

通用型指示灯和蜂鸣器

Ø22 mm

特性

带有LED的指示灯

符合标准	IEC 60947-5-1, EN 60 947-5-1, IEC 337
防护处理	标准版本: "TC"
环境温度	工作: - 25 ~ +70 °C。贮存: - 40 ~ +80°C
电子冲击保护	I级, 符合 IEC 536 和 NF C 20-030
防护等级	IP 65 符合 IEC 529 和 NF C 20-010
功率损耗	XB2-BVB●C XB2-BVM●C: 24V 0.5W 220V 4.5W
额定绝缘电压	50 - 380 V 符合 IEC 947-1 依类型而定
使用寿命	标称电压下可超过50,000 小时
电压极限	XB2-BVB●C XB2-BVM●C: $0.8U_n \leq U \leq 1.1U_n$
端子型号	X1, X2 符合 CENELEC EN 50013
接线	螺旋压入式端子 接线能力: 最小1x 0.5 mm ² , 最大2x 1.5 mm ² 或1x 2.5 mm ²

蜂鸣器特性

声音类型	连续蜂鸣
声音大小	100 dB / 10 cm
电气寿命	20000小时
额定电流	最大25 mA
电压波动	+/- 10%供电电压 冲击电压: 4 kV (线对地), 2 kV (线对线)

XB2B 金属系列按钮 Ø22 mm

型号说明

模块型号
ZB2B...C

完整型号
XB2B...C

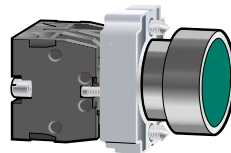
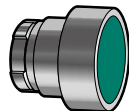
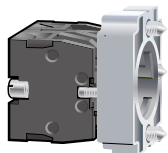

触点基座

按钮头

按钮

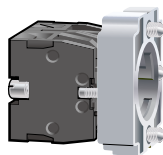
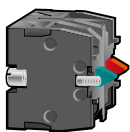
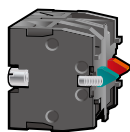

辅助触点的连接：最多可加至6付触点模块。

产品供货说明：
XB2B系列产品以分体模块形式供货，模块型号为ZB2B...C。

组成和附件

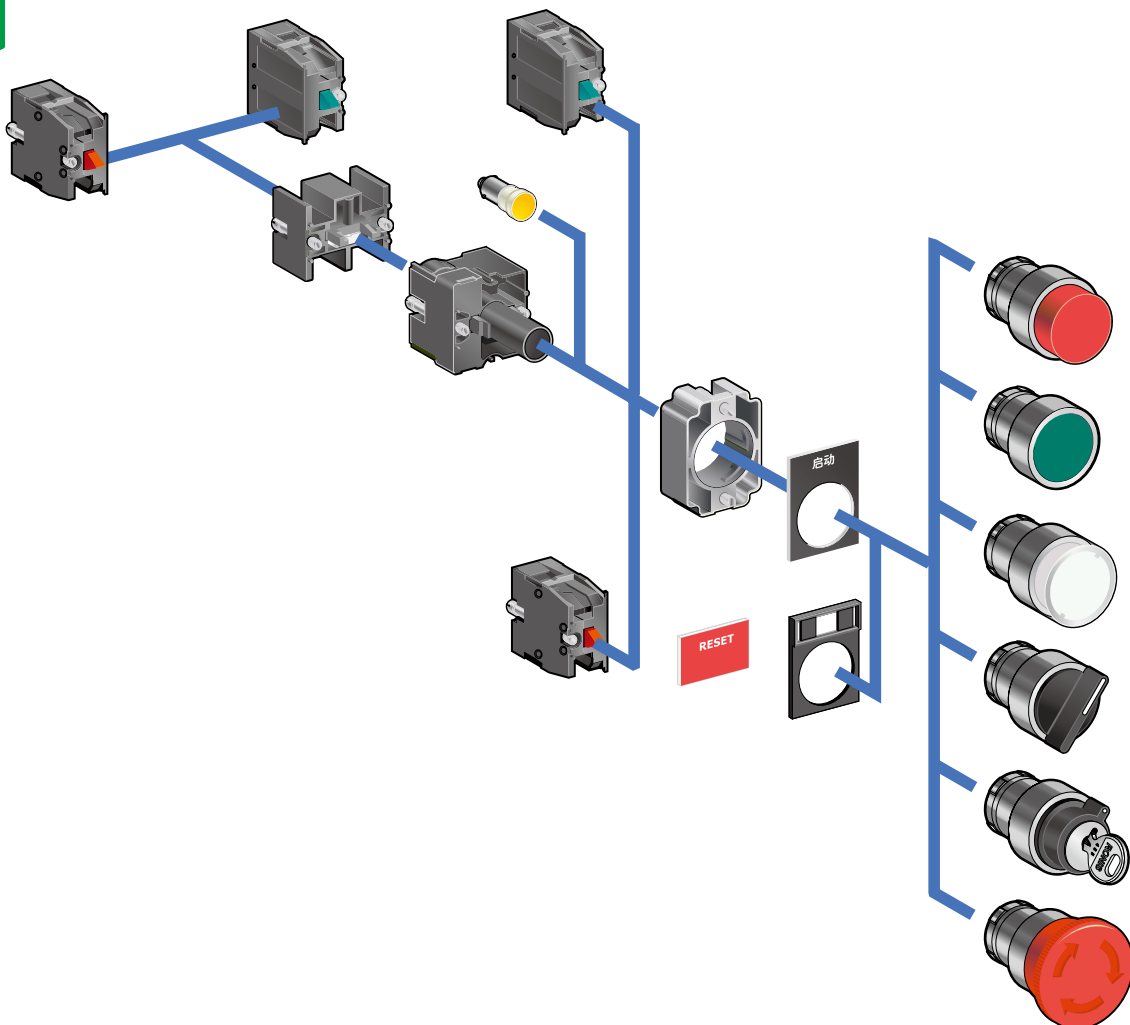

XB2B

金属系列按钮

Ø22 mm

按钮

弹簧复位按钮

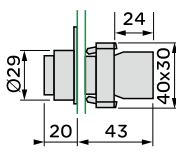
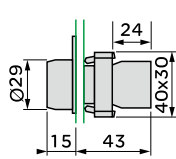
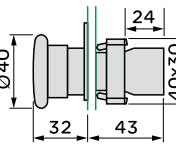
说明	颜色	触点类型		型号	重量	尺寸
		常开	常闭			
 XB2BA**C 平头按钮	○	1		XB2BA11C	0.070	
	●	1		XB2BA21C	0.070	
	●	1		XB2BA31C	0.070	
	●	1		XB2BA51C	0.070	
	●	1		XB2BA61C	0.070	
	●		1	XB2BA22C	0.070	
	●		1	XB2BA42C	0.070	
 XB2BL**C 凸头按钮	●	1		XB2BL21C	0.070	
	●	1		XB2BL31C	0.070	
	●	1		XB2BL51C	0.070	
	●	1		XB2BL61C	0.070	
	●		1	XB2BL22C	0.070	
	●		1	XB2BL42C	0.070	
 XB2BP**C 带罩按钮	●	1		XB2BP21C	0.070	
	●	1		XB2BP31C	0.070	
	●	1		XB2BP51C	0.070	
	●	1		XB2BP61C	0.070	
	●		1	XB2BP42C	0.070	
 XB2BC**C 蘑菇头按钮 Ø40 mm	●	1		XB2BC21C	0.090	
	●	1		XB2BC31C	0.090	
	●	1		XB2BC51C	0.090	
	●	1		XB2BC61C	0.090	
	●		1	XB2BC42C	0.090	
 XB2BR**C 蘑菇头按钮 Ø60 mm	●	1		XB2BR21C	0.095	
	●		1	XB2BR42C	0.095	

XB2B

金属系列按钮

Ø22 mm

按钮

带功能符号的弹簧复位按钮

说明	标记 颜色	触点类型		型号	重量	尺寸	
		常开	常闭				
 平头按钮 XB2BA****C		1		XB2BA3311C	0.070		
		1		XB2BA3341C	0.070		
		1		XB2BA3351C	0.070		
			1		XB2BA4322C		0.070
			1		XB2BA4342C		0.070
 凸头按钮 XB2BL****C			1	XB2BL4322C	0.070		
			1	XB2BL4342C	0.070		

锁扣式蘑菇头“紧急停止”按钮

说明		触点类型		型号	重量	尺寸
		常开	常闭			
 按拉式 红色 XB2BT(X)**C	Ø40		1	XB2BT42C	0.115	
	Ø60		1	XB2BX42C	0.120	
 转动复位 红色 XB2BS****C	Ø30		1	XB2BS442C	0.085	
	Ø40		1	XB2BS542C	0.095	
	Ø60		1	XB2BS642C	0.105	
 钥匙复位 红色 XB2BS****C	Ø30		1	XB2BS742C	0.130	
	Ø40		1	XB2BS142C	0.140	
	Ø60		1	XB2BS242C	0.160	

带有“触发动作”的锁扣式蘑菇头“紧急停止”按钮

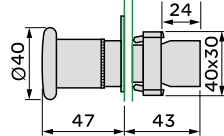
说明		触点类型		型号	重量	尺寸
		常开	常闭			
 转动复位 红色 XB2BS****C	Ø40	1	1	XB2BS8445C	0.115	
	Ø40	1	1	XB2BS9445C	0.135	





XB2B

金属系列按钮

Ø22 mm

选择开关

标准手柄

说明	位置	触点类型		型号	重量	尺寸	
		常开	常闭				
 XB2BD**C	2位		1		XB2BD21C	0.085	
			1	1	XB2BD25C	0.100	
			1		XB2BD41C	0.085	
			1	1	XB2BD45C	0.100	
	3位	  	2		XB2BD33C	0.100	
			2		XB2BD53C	0.100	
			2		XB2BD73C	0.100	

长手柄

说明	位置	触点类型		型号	重量	尺寸	
		常开	常闭				
 XB2BJ**C	2位		1		XB2BJ21C	0.085	
			1	1	XB2BJ25C	0.100	
			1		XB2BJ41C	0.085	
			1	1	XB2BJ45C	0.100	
	3位	  	2		XB2BJ33C	0.100	
			2		XB2BJ53C	0.100	
			2		XB2BJ73C	0.100	

标记说明:  锁定  弹簧返回

钥匙开关

说明	位置	触点类型		型号	重量	尺寸	
		常开	常闭				
 XB2BG**C	2位		1		XB2BG21C	0.110	
			1	1	XB2BG25C	0.125	
			1		XB2BG41C	0.110	
			1	1	XB2BG45C	0.125	
			1		XB2BG61C	0.110	
			1	1	XB2BG65C	0.125	
	3位	   	2		XB2BG33C	0.125	
			2		XB2BG53C	0.125	
			2		XB2BG03C	0.125	
			2		XB2BG73C	0.125	

标记说明:  锁定  弹簧返回  钥匙抽出

XB2B

金属系列按钮

Ø22 mm

带灯按钮



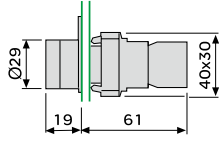





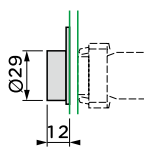

平头带灯按钮 (弹簧返回)

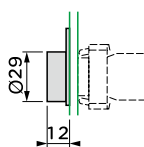
	电源电压	颜色	触点类型		型号	重量	尺寸
			常开	常闭			
 XB2BW***C	交直流24V	○	1		XB2BW31B1C	0.120	
	含LED灯泡	●	1		XB2BW33B1C	0.120	
		●	1		XB2BW34B1C	0.120	
		●	1		XB2BW35B1C	0.120	
		●	1		XB2BW36B1C	0.120	
	交流220V	○	1		XB2BW31M1C	0.120	
	含LED灯泡	●	1		XB2BW33M1C	0.120	
		●	1		XB2BW34M1C	0.120	
		●	1		XB2BW35M1C	0.120	
		●	1		XB2BW36M1C	0.120	

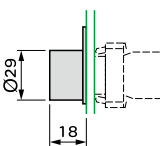
XB2B 金属系列按钮 Ø22 mm

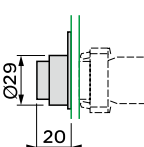
按钮头

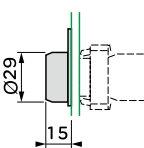

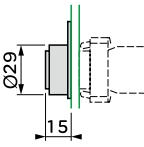



弹簧复位按钮头

	说明	颜色	型号	重量 (kg)	尺寸
 ZB2BA•C	平头按钮头	○	ZB2BA1C	0.030	
		●	ZB2BA2C	0.030	
		●	ZB2BA3C	0.030	
		●	ZB2BA4C	0.030	
		●	ZB2BA5C	0.030	
		●	ZB2BA6C	0.030	
 ZB2BA•8C	平头半透明式按钮头	●	ZB2BA38C	0.030	
		●	ZB2BA48C	0.030	
		●	ZB2BA58C	0.030	
		●	ZB2BA68C	0.030	
		透明	ZB2BA78C	0.030	
 ZB2BA•6C	带保护罩凹入式按钮头	○	ZB2BA16C	0.040	
		●	ZB2BA26C	0.040	
		●	ZB2BA36C	0.040	
		●	ZB2BA46C	0.040	
		●	ZB2BA56C	0.040	
		●	ZB2BA66C	0.040	
 ZB2BL•C	凸头按钮头	○	ZB2BL1C	0.030	
		●	ZB2BL2C	0.030	
		●	ZB2BL3C	0.030	
		●	ZB2BL4C	0.030	
		●	ZB2BL5C	0.030	
		●	ZB2BL6C	0.030	
 ZB2BP•C	带罩按钮头	●	ZB2BP2C	0.025	
		●	ZB2BP3C	0.025	
		●	ZB2BP4C	0.025	
		●	ZB2BP5C	0.025	
		●	ZB2BP6C	0.025	
		●	ZB2BP6C	0.025	
 ZB2BP•8C	半透明罩按钮头	●	ZB2BP38C	0.030	
		●	ZB2BP48C	0.030	
		●	ZB2BP58C	0.030	
		●	ZB2BP68C	0.030	
		透明	ZB2BP78C	0.030	

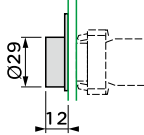
XB2B 金属系列按钮 Ø22 mm

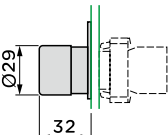
按钮头

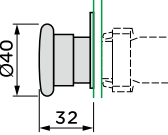

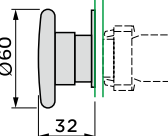



弹簧复位按钮头

	说明	标记 颜色	型号	重量 (kg)	尺寸
 ZB2BA***C	带功能符号平头按钮头	ⓘ	ZB2BA131C	0.030	
		Ⓜ	ZB2BA331C	0.030	
		Ⓜ	ZB2BA136C	0.030	
		Ⓜ	ZB2BA336C	0.030	
		Ⓜ	ZB2BA334C	0.030	
		Ⓜ	ZB2BA335C	0.030	
		Ⓜ	ZB2BA232C	0.030	
		Ⓜ	ZB2BA432C	0.030	
		STOP	ZB2BA234C	0.030	
		STOP	ZB2BA434C	0.030	
		 ZB2BL***C	带功能符号凸头按钮头	Ⓜ	
Ⓜ	ZB2BL432C			0.030	
STOP	ZB2BL234C			0.030	
STOP	ZB2BL434C			0.030	
 ZB2BC*4C	蘑菇头按钮头 Ø30 mm	●	ZB2BC24C	0.045	
		●	ZB2BC34C	0.045	
		●	ZB2BC44C	0.045	
		●	ZB2BC54C	0.045	
		●	ZB2BC64C	0.045	
 ZB2BC*C	蘑菇头按钮头 Ø40 mm	●	ZB2BC2C	0.045	
		●	ZB2BC3C	0.045	
		●	ZB2BC4C	0.045	
		●	ZB2BC5C	0.045	
		●	ZB2BC6C	0.045	
 ZB2BR*C	蘑菇头按钮头 Ø60 mm	●	ZB2BR2C	0.055	
		●	ZB2BR3C	0.055	
		●	ZB2BR4C	0.055	
		●	ZB2BR5C	0.055	
		●	ZB2BR6C	0.055	

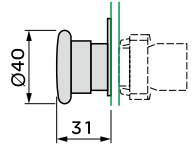
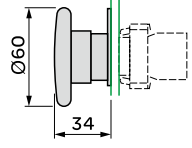
XB2B 金属系列按钮 Ø22 mm

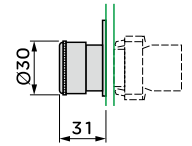
按钮头

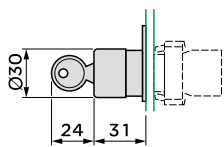
锁定式急停按钮头

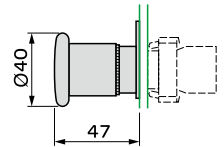
	说明	颜色	型号	重量 (kg)	尺寸		
 ZB2BT(X)•C	蘑菇头按钮头 拉拔复位	Ø40 mm	●	ZB2BT2C	0.075		
			●	ZB2BT3C	0.075		
			●	ZB2BT4C	0.075		
			●	ZB2BT5C	0.075		
			●	ZB2BT6C	0.075		
			●	ZB2BT6C	0.075		
	Ø60 mm	●	ZB2BX2C	0.080			
		●	ZB2BX4C	0.080			
 ZB2BS••C	蘑菇头按钮头 转动复位	Ø30 mm	●	ZB2BS42C	0.045		
			●	ZB2BS43C	0.045		
			●	ZB2BS44C	0.045		
			●	ZB2BS45C	0.045		
			●	ZB2BS46C	0.045		
			Ø40 mm	●	ZB2BS52C		0.055
				●	ZB2BS54C		0.055
				●	ZB2BS55C		0.055
			Ø60 mm	●	ZB2BS62C		0.065
		●	ZB2BS64C	0.065			
 ZB2BS•••C	蘑菇头按钮头 钥匙复位	Ø30 mm	●	ZB2BS72C	0.090		
			●	ZB2BS74C	0.090		
			Ø40 mm	●	ZB2BS12C		0.090
				●	ZB2BS14C		0.090
			Ø60 mm	●	ZB2BS22C		0.120
				●	ZB2BS24C		0.120
 ZB2BS••••C	带触发动作的 蘑菇头按钮头 转动复位	Ø30 mm	●	ZB2BS834C	0.060		
			Ø40 mm	●	ZB2BS844C		0.060
	带触发动作的 蘑菇头按钮头 钥匙复位	Ø30 mm	●	ZB2BS934C	0.080		
		Ø40 mm	●	ZB2BS944C	0.080		
		Ø60 mm	●	ZB2BS964C	0.110		
		Ø60 mm	●	ZB2BS964C	0.110		

XB2B 金属系列按钮 Ø22 mm

选择开关头

标准手柄选择开关头

	说明	位置	型号	重量 (kg)	尺寸
 ZB2BD-C	2位	∨	ZB2BD2C	0.045	
		◊	ZB2BD4C	0.045	
	3位	∨	ZB2BD3C	0.045	
		◊	ZB2BD5C	0.045	
		∨	ZB2BD7C	0.045	
∨	ZB2BD8C	0.045			

长手柄选择开关头

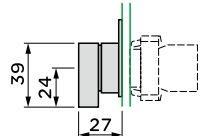
	说明	位置	型号	重量 (kg)	尺寸
 ZB2BJ-C	2位	∨	ZB2BJ2C	0.045	
		◊	ZB2BJ4C	0.045	
	3位	∨	ZB2BJ3C	0.045	
		◊	ZB2BJ5C	0.045	
		∨	ZB2BJ7C	0.045	
∨	ZB2BJ8C	0.045			

钥匙开关头











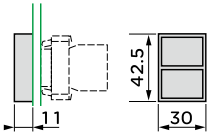

钥匙开关头

	说明	位置	型号	重量 (kg)	尺寸
 ZB2BG-C	2位	∨	ZB2BG2C	0.070	
		∨	ZB2BG4C	0.070	
		◊	ZB2BG6C	0.070	
	3位	∨	ZB2BG3C	0.070	
		∨	ZB2BG5C	0.070	
		∨	ZB2BG9C	0.070	
		∨	ZB2BG09C	0.070	
		∨	ZB2BG0C	0.070	
		◊	ZB2BG7C	0.070	
		∨	ZB2BG1C	0.070	
∨	ZB2BG8C	0.070			

标记说明: ∨ 锁定 ◊ 弹簧返回 钥匙抽出

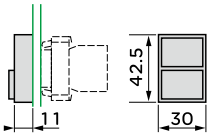



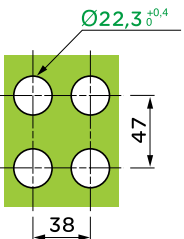





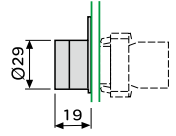

双头按钮头

弹簧复位

说明	标记 颜色	型号	重量 (kg)	尺寸
 2平头 ZB2BA****		ZB2BA9124	0.050	
		ZB2BA9134	0.050	
		ZB2BA9224	0.050	
		ZB2BA9234	0.050	
 1平头, 1凸头 ZB2BL****		ZB2BL9324	0.050	
		ZB2BL9334	0.050	
		ZB2BL9424	0.050	
		ZB2BL9434	0.050	
安装开孔图 (厚度: 1-6 mm)				

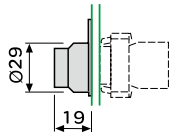
带灯按钮头

弹簧复位

说明	标记 颜色	型号	重量 (kg)	尺寸
 平头带灯按钮头 ZB2BW3•C		ZB2BW31C	0.030	
		ZB2BW33C	0.030	
		ZB2BW34C	0.030	
		ZB2BW35C	0.030	
		ZB2BW36C	0.030	
	透明	ZB2BW37C	0.030	
 凸头带灯按钮头 ZB2BW1•C		ZB2BW11C	0.030	
		ZB2BW13C	0.030	
		ZB2BW14C	0.030	
		ZB2BW15C	0.030	
		ZB2BW16C	0.030	

XB2B 金属系列按钮 Ø22 mm

带灯选择开关头

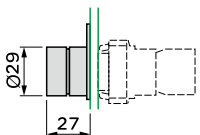
		说明	位置	颜色	型号	重量 (kg)	尺寸
 ZB2BK1••	2位		●	ZB2BK123	0.045		
			●	ZB2BK124	0.045		
			●	ZB2BK125	0.045		
			●	ZB2BK126	0.045		
			透明	ZB2BK127	0.045		
			●	ZB2BK143	0.045		
			●	ZB2BK144	0.045		
	3位		●	ZB2BK145	0.045		
			●	ZB2BK146	0.045		
			透明	ZB2BK147	0.045		
			●	ZB2BK133	0.045		
			●	ZB2BK134	0.045		
			●	ZB2BK135	0.045		
			●	ZB2BK136	0.045		
			透明	ZB2BK137	0.045		
			●	ZB2BK153	0.045		
			●	ZB2BK154	0.045		
	●	ZB2BK155	0.045				
	●	ZB2BK156	0.045				
	透明	ZB2BK157	0.045				
	●	ZB2BK173	0.045				
	●	ZB2BK174	0.045				
	●	ZB2BK175	0.045				
	●	ZB2BK176	0.045				
	透明	ZB2BK177	0.045				

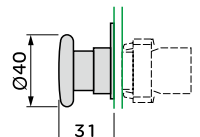
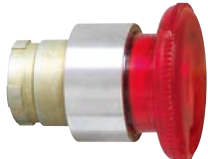

标记说明:  锁定  弹簧返回

带灯蘑菇头按钮头

		说明	颜色	型号	重量 (kg)	尺寸
 ZB2BW4•	弹簧返回	Ø40 mm	●	ZB2BW43	0.055	
			●	ZB2BW44	0.055	
			●	ZB2BW45	0.055	
			●	ZB2BW46	0.055	
			透明	ZB2BW47	0.055	
 ZB2BW6•	锁定式 拉拔复位	Ø40 mm	●	ZB2BW63	0.055	
			●	ZB2BW64	0.055	
			●	ZB2BW65	0.055	
			●	ZB2BW66	0.055	
			透明	ZB2BW67	0.055	

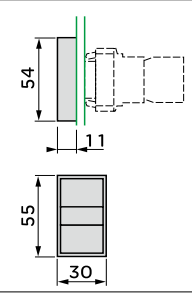

带指示灯双头按钮头

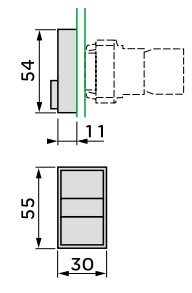
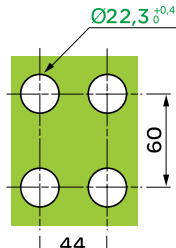
弹簧复位

	说明	颜色	型号	重量 (kg)	尺寸
 ZB2BW8***	2平头 中间指示灯		ZB2BW81254	0.060	
			ZB2BW81354	0.060	
			ZB2BW82254	0.060	
			ZB2BW82354	0.060	
 ZB2BW8***	1平头 中间指示灯 1凸头		ZB2BW83254	0.060	
			ZB2BW83354	0.060	
			ZB2BW84254	0.060	
			ZB2BW84354	0.060	
安装开孔图 (厚度: 1-6 mm)					

带灯按钮基座

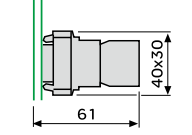
带灯按钮基座

	说明	颜色	触点类型	型号	重量 (kg)	尺寸
			常开 常闭			
 ZB2BW***C	交直流24V 含LED灯泡		1	ZB2BWB11C	0.090	
			1	ZB2BWB31C	0.090	
			1	ZB2BWB32C	0.090	
			1	ZB2BWB41C	0.090	
			1	ZB2BWB42C	0.090	
			1	ZB2BWB51C	0.090	
			1	ZB2BWB61C	0.090	
			1	ZB2BWM11C	0.090	
			1	ZB2BWM31C	0.090	
			1	ZB2BWM32C	0.090	
 ZB2BW06*C	直接电源 不含LED (BA 9s灯座) <380V 50 Hz		1	ZB2BW061C	0.090	
			1	ZB2BW062C	0.090	
			2	ZB2BW063C	0.090	
			2	ZB2BW064C	0.090	
			1	ZB2BW065C	0.090	

XB2B 金属系列按钮 Ø22 mm

触点基座

触点基座

说明	触点类型		型号	重量 (kg)	尺寸	
	常开	常闭				
 <p>ZB2BZ10•C</p> <p>带触点模块的基座，应用于客户的各种设计用途</p>	1		ZB2BZ101C	0.040		
		1	ZB2BZ102C	0.040		
	2		ZB2BZ103C	0.055		
		2	ZB2BZ104C	0.055		
		1	1	ZB2BZ105C		0.055
	先通后断	1	1	ZB2BZ106C		0.055
	先后接通	2		ZB2BZ107C		0.055

触点模块

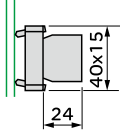
说明	触点类型		型号	重量 (kg)	尺寸
	常开	常闭			
 <p>ZB2BE10•C</p> <p>辅助/可替换的触点螺旋压入式端子</p>	1		ZB2BE101C	0.015	
		1	ZB2BE102C	0.015	

锁定模块

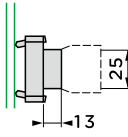
说明	型号	重量 (kg)	尺寸
 <p>ZB2BZ21C</p> <p>用于按钮(除“急停按钮”、选择、钥匙开关外)和带灯按钮安装于触点模块前面,实现按-锁定-按-释放</p>	ZB2BZ21C	0.015	

指示灯

通用型指示灯



XB2BV***LC

电源电压	颜色	型号	重量 (kg)	尺寸	
交直流24V 含LED灯泡	○	XB2BVB1LC	0.020		
	●	XB2BVB3LC	0.020		
	●	XB2BVB4LC	0.020		
	●	XB2BVB5LC	0.020		
	●	XB2BVB6LC	0.020		
	交直流48V 含LED灯泡	○	XB2BVE1LC		0.020
●		XB2BVE3LC	0.020		
●		XB2BVE4LC	0.020		
●		XB2BVE5LC	0.020		
直流110V 含LED灯泡		○	XB2BVD1LC		0.020
		●	XB2BVD3LC		0.020
	●	XB2BVD4LC	0.020		
	●	XB2BVD5LC	0.020		
	●	XB2BVD6LC	0.020		
	交流110V 含LED灯泡	○	XB2BVF1LC		0.020
●		XB2BVF3LC	0.020		
●		XB2BVF4LC	0.020		
●		XB2BVF5LC	0.020		
●		XB2BVF6LC	0.020		
直流220V 含LED灯泡		○	XB2BVM1LC		0.020
	●	XB2BVM3LC	0.020		
	●	XB2BVM4LC	0.020		
	●	XB2BVM5LC	0.020		
	●	XB2BVM6LC	0.020		
	交流220V 含LED灯泡	○	XB2BVM1LC	0.020	
●		XB2BVM3LC	0.020		
●		XB2BVM4LC	0.020		
●		XB2BVM5LC	0.020		
●		XB2BVM6LC	0.020		
交流380V 含LED灯泡		○	XB2BVQ1LC	0.020	
	●	XB2BVQ3LC	0.020		
	●	XB2BVQ4LC	0.020		
	●	XB2BVQ5LC	0.020		
	●	XB2BVQ6LC	0.020		

蜂鸣器



XB2BS*C

说明	电源电压	颜色	型号	重量 (kg)
持续声音 100 dB / 10 cm	交直流24V		XB2BSBC	0.017
	交流110V		XB2BSFC	0.017
	交流220V		XB2BSMC	0.017

XB5A

塑料系列模块式按钮

Ø22 mm

特性

环境

符合标准	IEC 60947-5-1, EN 60 947-5-1, GB 14048.1, GB 14048.5
防护处理	“TH”
环境温度	工作温度: -25 ~ +70 °C, 贮存温度: -40 ~ +70 °C
抗振性	5 gn (2-500Hz), 符合IEC 60068-2-6
电子冲击保护	II级, 符合 IEC 536
防护等级	IP65: 平头按钮, 带或不带指示灯
符合 IEC 529	
机械寿命	弹簧复位式按钮: 500万次, 选择开关: 100万次, 急停按钮: 30万次

触点特性

额定工作特性	~ AC-15: A600 或 Ue = 240 V 和 Ie = 3 A --- DC-13: Q600 或 Ue = 250 V 和 Ie = 0.27 A 符合 IEC 947-5-1附录 A
额定绝缘电压	Ui = 600 V, 污染等级 3, 符合 IEC 60947-1, Ui = 600 V
额定耐冲击电压	Uimp = 6 kV 符合 IEC 947-1
触头动作	慢断 (常闭或常开)
可靠工作	安全装置 (蘑菇头 “急停” 按钮): 常闭触点分断可靠, 符合 IEC 60947-5-1第3部分

操作压力	平头按钮 - 带1常开触点: 3.8 N - 带1常闭触点: 3.5 N 辅助触点 - 常开: + 2.3 N - 常闭: + 2 N
------	--

端子型号	符合 EN 50013和EN 50005
------	----------------------

短路保护	10 A 符合 IEC/EN 60947-5-1, 其中熔断器符合 IEC 60269-1
------	---

额定工作功率	符合 IEC 60947-5-1附录 C。应用范围 AC-15 和 DC-13。 操作频率: 3600 次操作/小时。 负载因数: 0.5
--------	---

交流电源 ~ 50-60 Hz

~ 感性电路

操作—百万次

	V	24	120	230
	A	4	3	2

直流电源 ---

操作—百万次

	V	24	110
	A	0.5	0.2

可靠性能	—亿次操作中, 故障率 < 1 (可编程控制器输入, 24 V d.c.)
------	---------------------------------------

接线	—螺旋压入式端子, 接线能力: 最小 1 × 0.22 mm ² , 不带接线端片 最大 2 × 1.5 mm ² , 带接线端片
----	--

XB5A 塑料系列按钮

Ø22 mm

型号说明

模块型号
ZB5A...C

完整型号
XB5A...C

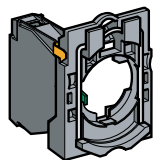

触点基座

按钮头

按钮

辅助触点的连接：最多可加至9付触点模块。

产品供货说明：

XB5A系列产品以分体模块形式供货，模块型号为ZB5A...C。

组成和附件

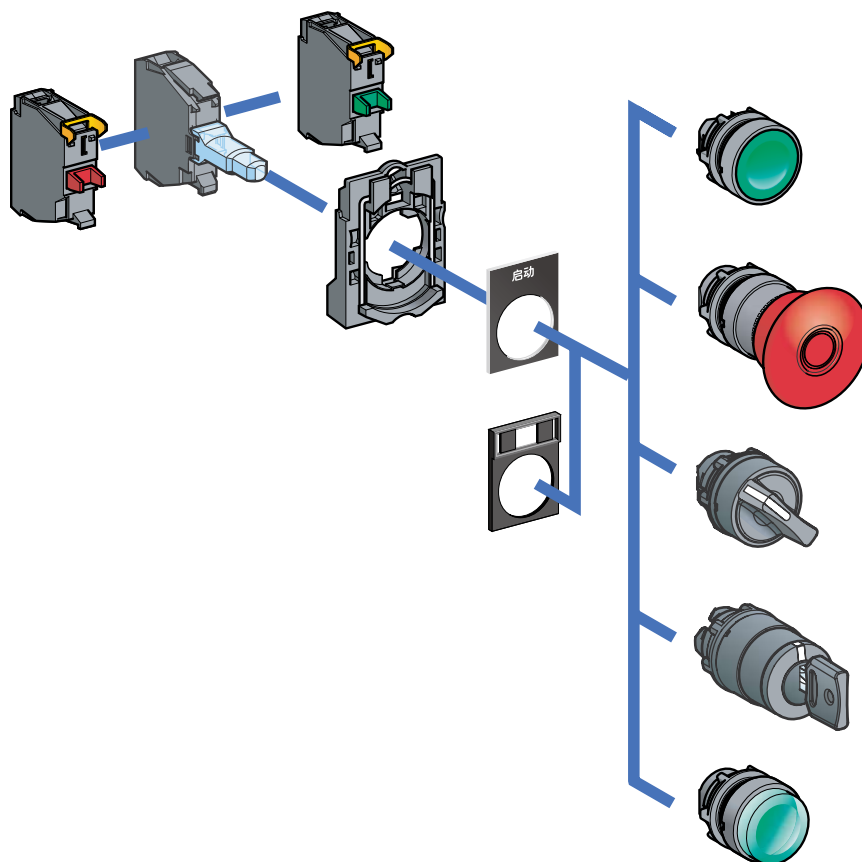

XB5A

塑料系列模块式按钮

Ø22 mm

按钮

说明		触点类型		型号	重量	尺寸
		常开	常闭			
 XB5AA**C	平头按钮 (弹簧返回)	○	1	XB5AA11C (ZB5AA1C+ZB5AZ101C)	0.070	
		●	1	XB5AA21C (ZB5AA2C+ZB5AZ101C)	0.070	
		●	1	XB5AA31C (ZB5AA3C+ZB5AZ101C)	0.070	
		●	1	XB5AA42C (ZB5AA4C+ZB5AZ102C)	0.070	
		●	1	XB5AA51C (ZB5AA5C+ZB5AZ101C)	0.070	
		●	1	XB5AA61C (ZB5AA6C+ZB5AZ101C)	0.070	

急停按钮

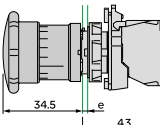
说明		触点类型		型号	重量	尺寸
		常开	常闭			
 XB5AS542C	Ø40 mm红色蘑菇头 转动复位		1	XB5AS542C (ZB5AS54C+ZB5AZ102C)	0.070	

选择开关

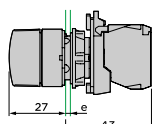
说明		触点类型		型号	重量	尺寸
		常开	常闭			
 XB5AD**C	2位锁定	∨	1	XB5AD21C (ZB5AD2C+ZB5AZ101C)	0.040	
	3位锁定	∨	2	XB5AD33C (ZB5AD3C+ZB5AZ103C)	0.055	

钥匙开关

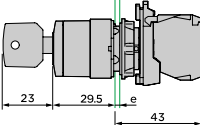
说明		触点类型		型号	重量	尺寸
		常开	常闭			
 XB5AG**C	2位锁定 左侧钥匙抽出	∨	1	XB5AG21C (ZB5AG2C+ZB5AZ101C)	0.065	
	3位锁定 中间钥匙抽出	∨	2	XB5AG33C (ZB5AG3C+ZB5AZ103C)	0.080	

标记说明: ∨ 锁定 ∩ 弹簧返回 ⚙ 钥匙抽出

XB5A

塑料系列模块式按钮

Ø22 mm

带灯按钮

平头带灯按钮 (弹簧返回)



XB5A****C

电源电压	颜色	触点类型		型号	重量	尺寸
		常开	常闭			
交直流24V 含LED灯泡		1		XB5AW31B1C (ZB5AW313C+ZB5AW0B11C)	0.055	
		1		XB5AW33B1C (ZB5AW333C+ZB5AW0B31C)	0.055	
		1		XB5AW34B1C (ZB5AW343C+ZB5AW0B41C)	0.055	
			1	XB5AW34B2C (ZB5AW343C+ZB5AW0B42C)	0.055	
		1		XB5AW35B1C (ZB5AW353C+ZB5AW0B51C)	0.055	
		1		XB5AW36B1C (ZB5AW363C+ZB5AW0B61C)	0.055	
交流110V 含LED灯泡		1		XB5AW31G1C (ZB5AW313C+ZB5AW0G11C)	0.055	
		1		XB5AW33G1C (ZB5AW333C+ZB5AW0G31C)	0.055	
		1		XB5AW34G1C (ZB5AW343C+ZB5AW0G41C)	0.055	
			1	XB5AW34G2C (ZB5AW343C+ZB5AW0G42C)	0.055	
		1		XB5AW35G1C (ZB5AW353C+ZB5AW0G51C)	0.055	
		1		XB5AW36G1C (ZB5AW363C+ZB5AW0G61C)	0.055	
交流220V 含LED灯泡		1		XB5AW31M1C (ZB5AW313C+ZB5AW0M11C)	0.055	
		1		XB5AW33M1C (ZB5AW333C+ZB5AW0M31C)	0.055	
		1		XB5AW34M1C (ZB5AW343C+ZB5AW0M41C)	0.055	
			1	XB5AW34M2C (ZB5AW343C+ZB5AW0M42C)	0.055	
		1		XB5AW35M1C (ZB5AW353C+ZB5AW0M51C)	0.055	
		1		XB5AW36M1C (ZB5AW363C+ZB5AW0M61C)	0.055	
交流380V 含LED灯泡		1		XB5AW31Q1C (ZB5AW313C+ZB5AW0Q11C)	0.055	
		1		XB5AW33Q1C (ZB5AW333C+ZB5AW0Q31C)	0.055	
		1		XB5AW34Q1C (ZB5AW343C+ZB5AW0Q41C)	0.055	
			1	XB5AW34Q2C (ZB5AW343C+ZB5AW0Q42C)	0.055	
		1		XB5AW35Q1C (ZB5AW353C+ZB5AW0Q51C)	0.055	
		1		XB5AW36Q1C (ZB5AW363C+ZB5AW0Q61C)	0.055	

按钮头

弹簧复位按钮头

说明	颜色	型号	重量 (kg)	
 ZB5AA•C	平头按钮头	○	ZB5AA1C	0.015
		●	ZB5AA2C	0.015
		●	ZB5AA3C	0.015
		●	ZB5AA4C	0.015
		●	ZB5AA5C	0.015
		●	ZB5AA6C	0.015

选择开关头

说明	位置	型号	重量 (kg)	
 ZB5AD•C	2位锁定	∨	ZB5AD2C	0.020
	3位锁定	∨	ZB5AD3C	0.020

钥匙开关头

说明	位置	型号	重量 (kg)	
 ZB5AG•C	2位锁定 左侧钥匙抽出	∨	ZB5AG2C	0.045
	3位锁定 中间钥匙抽出	∨	ZB5AG3C	0.045

标记说明: ∨ 锁定 ⚙ 钥匙抽出

锁定式急停按钮头

说明	颜色	型号	重量 (kg)	
 ZB5AS54C	蘑菇头按钮头 转动复位	●	ZB5AS54C	0.050

弹簧复位带灯按钮头

说明	颜色	型号	重量 (kg)	
 ZB5AW3••C	平头按钮头	○	ZB5AW313C	0.015
		●	ZB5AW333C	0.015
		●	ZB5AW343C	0.015
		●	ZB5AW353C	0.015
		●	ZB5AW363C	0.015

XB5A

塑料系列模块式按钮

Ø22 mm

触点基座

触点基座

	说明	触点类型		型号	重量		
		常开	常闭				
 <p>ZB5AZ10•C</p>	带触点模块的基座，应用于客户的各种设计用途	1		ZB5AZ101C	0.020		
			1		ZB5AZ102C	0.020	
				2		ZB5AZ103C	0.030
				2		ZB5AZ104C	0.030
				1	1	ZB5AZ105C	0.030

触点模块

	说明	触点类型		型号	重量
		常开	常闭		
 <p>ZBEE10•C</p>	辅助/可替换的触点螺旋压入式端子	1		ZBEE101C	0.015
				1	

XB5A

塑料系列模块式按钮

Ø22 mm

带灯按钮基座

带灯按钮基座



ZB5AW0***C

说明	颜色	触点类型		型号	重量
		常开	常闭		
交直流24V 含LED灯泡	○	1		ZB5AWOB11C	0.040
	●	1		ZB5AWOB31C	0.040
	●		1	ZB5AWOB32C	0.040
	●	1		ZB5AWOB41C	0.040
	●		1	ZB5AWOB42C	0.040
	●	1		ZB5AWOB51C	0.040
	●	1		ZB5AWOB61C	0.040
交流110V 含LED灯泡	○	1		ZB5AWOG11C	0.040
	●	1		ZB5AWOG31C	0.040
	●		1	ZB5AWOG32C	0.040
	●	1		ZB5AWOG41C	0.040
	●		1	ZB5AWOG42C	0.040
	●	1		ZB5AWOG51C	0.040
	●	1		ZB5AWOG61C	0.040
交流220V 含LED灯泡	○	1		ZB5AWOM11C	0.040
	●	1		ZB5AWOM31C	0.040
	●		1	ZB5AWOM32C	0.040
	●	1		ZB5AWOM41C	0.040
	●		1	ZB5AWOM42C	0.040
	●	1		ZB5AWOM51C	0.040
	●	1		ZB5AWOM61C	0.040
交流380V 含LED灯泡	○	1		ZB5AWOQ11C	0.040
	●	1		ZB5AWOQ31C	0.040
	●		1	ZB5AWOQ32C	0.040
	●	1		ZB5AWOQ41C	0.040
	●		1	ZB5AWOQ42C	0.040
	●	1		ZB5AWOQ51C	0.040
	●	1		ZB5AWOQ61C	0.040

特性

一体式按钮

符合标准	IEC 60947-5-1, GB14048.1, GB14048.5
防护处理	标准版本: “TC”
环境温度	工作: - 25 ~ +70 °C, 贮存: - 40 ~ +80°C
电子冲击保护	I级, 符合 IEC 536 和 NF C 20-030
防护等级	IP 40 (前部), 后部防指触设计
额定工作电流	0.3 A (AC240V), AC-14
额定绝缘电压	250 V
使用寿命	一百万次
接线	螺旋压入式端子 接线能力: 最小1x0.5 mm ² , 最大2x1.5 mm ² 或1x2.5 mm ²

带有LED的指示灯

符合标准	IEC 60947-5-1, GB14048.1, GB14048.5
防护处理	标准版本: “TC”
环境温度	工作: - 25 ~ +70 °C, 贮存: - 40 ~ +80°C
电子冲击保护	I级, 符合 IEC 536 和 NF C 20-030
防护等级	IP 40 (前部), 后部防指触设计
功率损耗	24V 0.5W 220V 4.5W
额定绝缘电压	50 ~ 380 V 符合 IEC 947-1 依类型而定
使用寿命	标称电压下可超过50,000 小时
电压极限	$0.8U_n \leq U \leq 1.1U_n$
端子型号	X1, X2 符合 CENELEC EN 50013
接线	螺旋压入式端子 接线能力: 最小1x0.5 mm ² , 最大2x1.5 mm ² 或1x2.5 mm ²

XB7E

塑料系列一体式按钮

Ø22 mm

一体式按钮

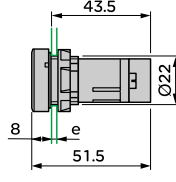
说明	颜色	触点类型			型号	重量	尺寸	
		常开	常闭	C/O				
 XB7EA**C	●	1			XB7EA21C	0.020		
		2			XB7EA23C	0.020		
				1		XB7EA25C		0.020
		1				XB7EA31C		0.020
		2				XB7EA33C		0.020
					1	XB7EA35C		0.020
	●			1		XB7EA42C		0.020
					1	XB7EA45C		0.020
		●		1		XB7EA51C		0.020

XB7E

优化型指示灯

Ø22 mm

指示灯

塑料系列指示灯



XB7E***LC

说明	电源电压	颜色	型号	重量 (kg)	尺寸	
含LED灯泡	交直流24V	○	XB7EVB1LC	0.017		
		●	XB7EVB3LC	0.017		
		●	XB7EVB4LC	0.017		
		●	XB7EVB5LC	0.017		
		●	XB7EVB6LC	0.017		
		○	XB7EVF1LC	0.017		
	交流110V	●	XB7EVF3LC	0.017		
		●	XB7EVF4LC	0.017		
		●	XB7EVF5LC	0.017		
		●	XB7EVF6LC	0.017		
		直流110V	○	XB7EVFD1LC		0.017
			●	XB7EVFD3LC		0.017
	●		XB7EVFD4LC	0.017		
	●		XB7EVFD5LC	0.017		
	●		XB7EVFD6LC	0.017		
	交流220V		○	XB7EVM1LC		0.017
		●	XB7EVM3LC	0.017		
		●	XB7EVM4LC	0.017		
		●	XB7EVM5LC	0.017		
		●	XB7EVM6LC	0.017		
		直流220V	○	XB7EVMD1LC		0.017
	●		XB7EVMD3LC	0.017		
	●		XB7EVMD4LC	0.017		
	●		XB7EVMD5LC	0.017		
●	XB7EVMD6LC		0.017			
交流380V	○		XB7EVQ1LC	0.017		
	●	XB7EVQ3LC	0.017			
	●	XB7EVQ4LC	0.017			
	●	XB7EVQ5LC	0.017			
	●	XB7EVQ6LC	0.017			

主令开关

说明	触点类型		型号	重量 (kg)	尺寸
	常开	常闭			
2位 	锁定	2	XD2PA12CR	0.115	
	弹簧返回	2	XD2PA22CR	0.115	
4位 	锁定	4	XD2PA14CR	0.145	
	弹簧返回	4	XD2PA24CR	0.145	

XD2PA**CR

主令开关的安装开孔图

安装面板厚度: 1~6mm

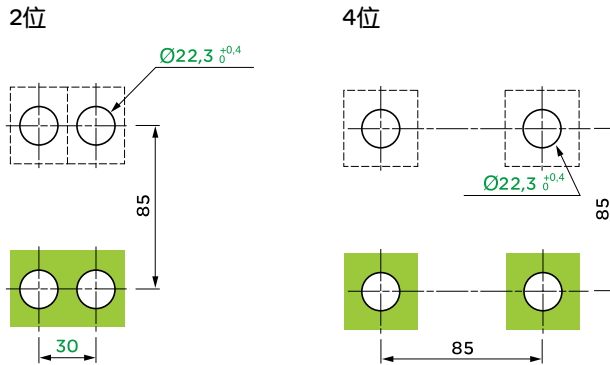

灯泡

说明	电源 电压	标记 颜色	型号	重量
				(kg)
LED灯泡 BA 9s灯座 	交直流 24V	○	DL1-LED241	0.002
		●	DL1-LED243	0.002
		●	DL1-LED244	0.002
		●	DL1-LED245	0.002
		●	DL1-LED246	0.002

DL1-LED***

标签及标牌

环形刻度板(用于蘑菇头按钮)





说明	标记 颜色	型号	重量 (kg)	尺寸
空白	白底或黄底	ZB2BY9101C	0.006	Ø60
		ZB2BY8101	0.008	Ø90
英文文字 “Emergency stop”	黄底黑字	ZB2BY9330C	0.006	Ø60
		ZB2BY8330	0.008	Ø90

ZB2BY****

其它标签及标牌请与当地的区域办事处联系。

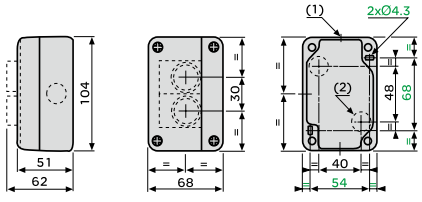
按钮盒

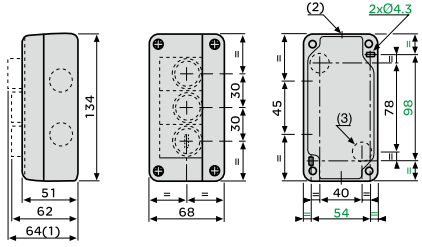
按钮盒

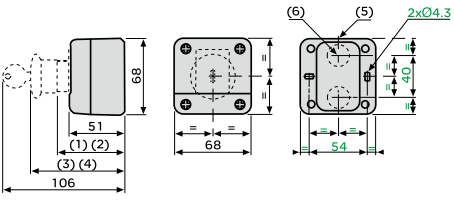
	说明	开孔 个数	型号	尺寸
 <p>XALBE01C</p>	底座和盒盖安装	1	XALBE01C	 <p>(1) 4 Ø 20mm 敲落孔, 最大线径 12mm (2) 2 Ø 19mm 敲落孔, 用于底部进线</p>
	适用于塑料系列按钮指示灯	2	XALBE02C	
	IP40	3	XALBE03C	
	不含按钮			
 <p>XALB01C</p>	底座和盒盖安装	1	XALB01C	 <p>(1) 指示灯 (2) 6 Ø 20mm 敲落孔, 最大线径 12mm (3) 2 Ø 19mm 敲落孔, 用于底部进线</p>
	适用于金属系列按钮指示灯	2	XALB02C	
	IP65	3	XALB03C	
	不含按钮 安装1个金属按钮+1个指示灯	2	XALB021C	
	安装2个金属按钮+1个指示灯	3	XALB031C	
 <p>XALB01YC</p>	急停按钮盒 不含急停按钮	1	XALB01YC	 <p>(1) 62mm 带按钮 (2) 77mm 带选择开关 (3) 82mm 带蘑菇头按钮 (4) 102mm 带可触发动作的蘑菇头按钮 (5) 2 Ø 20mm 敲落孔, 最大线径 12mm (6) 2 Ø 19mm 敲落孔, 用于底部进线</p>
	IP65 含急停按钮	1	XALJ01C	

孔塞

	说明	型号	重量 (kg)
 <p>ZB2SZ3</p>	Ø22黑色孔塞	ZB2SZ3	0.020

标签及标牌

8x27mm 嵌入式标签 (与ZB2BZ32配合使用)

		颜色和文字	型号	颜色和文字	型号	尺寸
 ZBY*****C		START	ZBY02303C	STOP	ZBY02304C	
		ON	ZBY02311C	EMERGENCY STOP	ZBY02330C	
		OFF	ZBY02312C	STOP	ZBY04304C	
		O	ZBY02146C	EMERGENCY STOP	ZBY04330C	
		I	ZBY02147C	停止	ZBY0C2304C	
		II	ZBY02148C	紧急停止	ZBY0C2330C	
		OFF - ON	ZBY02367C	停止	ZBY0C4304C	
		STOP - START	ZBY02366C	紧急停止	ZBY0C4330C	

18x27mm 嵌入式标签 (与ZB2BZ33配合使用)

		颜色和文字	型号	颜色和文字	型号	尺寸
 ZBY*****C		START	ZBY502303C	STOP	ZBY502304C	
		ON	ZBY502311C	EMERGENCY STOP	ZBY502330C	
		OFF	ZBY502312C	STOP	ZBY504304C	
		O	ZBY502146C	EMERGENCY STOP	ZBY504330C	
		I	ZBY502147C	停止	ZBY50C2304C	
		II	ZBY502148C	紧急停止	ZBY50C2330C	
		OFF - ON	ZBY502367C	停止	ZBY50C4304C	
		STOP - START	ZBY502366C	紧急停止	ZBY50C4330C	

30x40mm 一体式标牌

		颜色和文字	型号	颜色和文字	型号	尺寸
 ZB2BY*****C		START	ZB2BY2303C	STOP	ZB2BY2304C	
		ON	ZB2BY2311C	EMERGENCY STOP	ZB2BY2330C	
		OFF	ZB2BY2312C	STOP	ZB2BY4304C	
		O	ZB2BY2146C	EMERGENCY STOP	ZB2BY4330C	
		I	ZB2BY2147C	停止	ZB2BYC2304C	
		II	ZB2BY2148C	紧急停止	ZB2BYC2330C	
		OFF - ON	ZB2BY2367C	停止	ZB2BYC4304C	
		STOP - START	ZB2BY2366C	紧急停止	ZB2BYC4330C	

30x50mm 一体式标牌

		颜色和文字	型号	颜色和文字	型号	尺寸
 ZB2BY*****C		START	ZB2BY52303C	STOP	ZB2BY52304C	
		ON	ZB2BY52311C	EMERGENCY STOP	ZB2BY52330C	
		OFF	ZB2BY52312C	STOP	ZB2BY54304C	
		O	ZB2BY02146C	EMERGENCY STOP	ZB2BY54330C	
		I	ZB2BY02147C	停止	ZB2BYC52304C	
		II	ZB2BY02148C	紧急停止	ZB2BYC52330C	
		OFF - ON	ZB2BY02367C	停止	ZB2BYC54304C	
		STOP - START	ZB2BY02366C	紧急停止	ZB2BYC54330C	

标签及标牌

30x40mm 一体式标牌 (底部半圆)

	颜色和文字	型号	颜色和文字	型号	尺寸
 ZB2BYCR****C	空白(白底或黄底)	ZB2BYR4101C	空白(黑底或红底)	ZB2BYR2101C	
	启动	ZB2BYCR2303C	向后	ZB2BYCR2306C	
	电源	ZB2BYCR2326C	向右	ZB2BYCR2309C	
	开	ZB2BYCR2311C	向上	ZB2BYCR2307C	
	关	ZB2BYCR2312C	自动-手动	ZB2BYCR2364C	
	复位	ZB2BYCR0323C	自动-O-手动	ZB2BYCR2385C	
	运行	ZB2BYCR2334C	手动-关-自动	ZB2BYCR2387C	
	打开	ZB2BYCR2313C	关-开	ZB2BYCR2367C	
	关闭	ZB2BYCR2314C	停止-启动	ZB2BYCR2366C	
	向下	ZB2BYCR2308C	复位	ZB2BYCR2323C	
	向前	ZB2BYCR2305C	停止	ZB2BYCR2304C	
	手动	ZB2BYCR2316C	紧急停止	ZB2BYCR2330C	
	向左	ZB2BYCR2310C	停止	ZB2BYCR4304C	
			紧急停止	ZB2BYCR4330C	

标签标牌订货说明: 以上所有标签标牌均以10个为起订量。

“嵌入式”刻度板底座

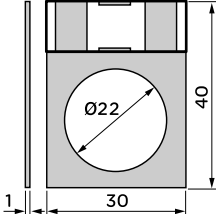
	说明	型号	重量 (kg)	尺寸
	30x40mm 用于8x27mm标签	ZB2BZ32	0.001	
	30x50mm 用于18x27mm标签	ZB2BZ33	0.001	

主令开关标签

	说明	标记 颜色	型号	尺寸
	配合XD2系列 主令开关使用	白色或黄色	ZD2GY2401C	30x48
		黑色或红色	ZD2GY2201C	30x48
	空白标签	白色或黄色	ZD2GY4401C	48x48
		黑色或红色	ZD2GY4201C	48x48



施耐德电气(中国)投资有限公司

施耐德电气(中国)投资有限公司	北京市朝阳区将台路2号和乔丽晶中心施耐德电气大厦	邮编: 100016	电话: (010) 84346699	传真: (010) 84501130
■ 上海分公司	上海市漕河泾开发区宜山路1009号创新大厦201室, 10-12, 15-16层	邮编: 200233	电话: (021) 24012500	传真: (021) 64957301
■ 广州分公司	广州市珠江新城临江大道3号发展中心大厦25层	邮编: 510623	电话: (020) 85185188	传真: (020) 85185195
■ 武汉分公司	武汉市汉口建设大道568号新世界国贸大厦1座37层01、02、03、05单元	邮编: 430022	电话: (027) 68850668	传真: (027) 68850488
■ 天津办事处	天津市河西区围堤道125号天信大厦22层2205-2207室	邮编: 300074	电话: (022) 28408408	传真: (022) 28408410
■ 天津分公司	天津市河东区十一经路78号万隆太平洋大厦1401-1404室	邮编: 300171	电话: (022) 84180888	传真: (022) 84180222
■ 济南办事处	济南市泺源大街229号金龙中心主楼21层D室	邮编: 250012	电话: (0531) 86121765	传真: (0531) 86121628
■ 青岛办事处	青岛香港中路59号国际金融中心35层3501B室	邮编: 266071	电话: (0532) 85793001	传真: (0532) 85793002
■ 石家庄办事处	石家庄市中山东路303号世贸皇冠酒店办公楼12层1201室	邮编: 050011	电话: (0311) 86698713	传真: (0311) 86698723
■ 沈阳办事处	沈阳沈河区青年大街219号华新国际大厦8层F/G/H/I座	邮编: 110016	电话: (024) 23964339	传真: (024) 23964296/4297
■ 哈尔滨办事处	哈尔滨南岗区红军街15号奥威斯发展大厦22层A、B座	邮编: 150001	电话: (0451) 53009797	传真: (0451) 53009639/9640
■ 长春办事处	长春解放大路 2677号长春光大银行大厦1211-12室	邮编: 130061	电话: (0431) 88400302/0303	传真: (0431) 88400301
■ 大连办事处	辽宁省大连市沙河口区五一一路267号17号楼201-1室	邮编: 116023	电话: (0411) 84769100	传真: (0411) 84769511
■ 西安办事处	西安高新区科技路48号创业广场B座17层1706室	邮编: 710075	电话: (029) 88332711	传真: (029) 88324697
■ 太原办事处	太原市府西街268号力鸿大厦B区1003室	邮编: 030002	电话: (0351) 4937186	传真: (0351) 4937029
■ 乌鲁木齐办事处	乌鲁木齐市新华北路5号美丽华酒店A座2521室	邮编: 830002	电话: (0991) 2825888 ext. 2521	传真: (0991) 2848188
■ 南京办事处	南京市中山路268号汇杰广场2001-2003室	邮编: 210008	电话: (025) 83198399	传真: (025) 83198321
■ 苏州办事处	苏州市工业园区苏华路2号国际大厦17层1711-1712单元	邮编: 215021	电话: (0512) 68622550	传真: (0512) 68622620
■ 无锡办事处	无锡市太湖广场永和路28号无锡工商综合大楼17层	邮编: 214021	电话: (0510) 81009780/61/62	传真: (0510) 81009760
■ 南通办事处	江苏省南通市跃龙路48号百乐门大酒店4001室	邮编: 226000	电话: (0513) 85586789	传真: (0513) 85586785
■ 常州办事处	常州市局前街2号常州椿庭楼宾馆1216室	邮编: 213000	电话: (0519) 88130710	传真: (0519) 88130711
■ 合肥办事处	合肥市长江东路1104号古井假日酒店820房间	邮编: 230011	电话: (0551) 4291993	传真: (0551) 2206956
■ 杭州办事处	杭州市凤起路78号浙金广场四层	邮编: 310003	电话: (0571) 85271466	传真: (0571) 85271305
■ 南昌办事处	江西南昌市八一大道357号财富广场A座2701室	邮编: 330046	电话: (0791) 6272972	传真: (0791) 6295323
■ 福州办事处	福州市仓山区建新镇闽江大道169号水乡温泉住宅区二期29楼102单元	邮编: 350000	电话: (0591) 87114853	传真: (0591) 87112046
■ 洛阳办事处	洛阳市涧西区凯旋西路88号华阳广场国际大饭店609室	邮编: 471003	电话: (0379) 65588678	传真: (0379) 65588679
■ 厦门办事处	厦门市思明区厦禾路189号银行中心2502-03A室	邮编: 361003	电话: (0592) 2386700	传真: (0592) 2386701
■ 宁波办事处	宁波市江东北路1号宁波中信国际大酒店833室	邮编: 315010	电话: (0574) 87706806	传真: (0574) 87717043
■ 温州办事处	温州市车站大道高联大厦写字楼9层B2号	邮编: 325000	电话: (0577) 86072225	传真: (0577) 86072228
■ 成都办事处	成都市顺城大街308号冠城广场27楼 A-F 座	邮编: 610017	电话: (028) 86528282	传真: (028) 86528383
■ 重庆办事处	重庆市渝中区邹容路68号重庆大都会商厦12楼11-12室	邮编: 400010	电话: (023) 63839700	传真: (023) 63839707
■ 佛山办事处	佛山市祖庙路33号百花广场26层2622-2623室	邮编: 528000	电话: (0757) 83990312/0029/1312	传真: (0757) 83992619
■ 昆明办事处	昆明市三市街6号柏联广场A座10层07-08单元	邮编: 650021	电话: (0871) 3647550	传真: (0871) 3647552
■ 长沙办事处	长沙市劳动西路215号湖南佳程酒店14层01、10-11单元	邮编: 410007	电话: (0731) 5112588	传真: (0731) 5159730
■ 郑州办事处	郑州市金水路115号中州皇冠假日酒店C座西翼二层	邮编: 450003	电话: (0371) 65939211	传真: (0371) 65939213
■ 中山办事处	中山市中山三路18号中银大厦18楼1813室	邮编: 528403	电话: (0760) 8235971	传真: (0760) 8235979
■ 鞍山办事处	鞍山市铁东区南胜利路21号万科写字楼2009室	邮编: 114001	电话: (0412) 5575511/5522	传真: (0412) 5573311
■ 烟台办事处	烟台市南大街9号金都大厦2514室	邮编: 264001	电话: (0535) 3393899	传真: (0535) 3393998
■ 南宁办事处	广西南宁市青秀区民族大道111号广西发展大厦10层	邮编: 530000	电话: (0771) 5519761/9762	传真: (0771) 5519760
■ 东莞办事处	东莞市南城区体育路2号鸿禧中心A406室	邮编: 523070	电话: (0769) 22413010	传真: (0769) 22413160
■ 深圳办事处	深圳市罗湖区深南东路5047号深圳发展银行大厦17层H-1室	邮编: 518001	电话: (0755) 25841022	传真: (0755) 82080250
■ 泰州办事处	江苏省泰州市江洲南路111号中丹宾馆328房间	邮编: 225300	电话: (0523) 86995328	传真: (0523) 86995326
■ 扬中办事处	扬中市前进北路52号扬中宾馆2018号房间	邮编: 212000	电话: (0511) 88398528	传真: (0511) 88398538
■ 贵阳办事处	贵阳市中华南路49号贵航大厦12层1204单元	邮编: 550002	电话: (0851) 5887006	传真: (0851) 5887009
■ 海口办事处	海南省海口市文华路18号海南文华大酒店6层607室	邮编: 570305	电话: (0898) 68597287	传真: (0898) 68597295
■ 施耐德(香港)有限公司	香港鲗鱼涌英皇道979号太古坊和域大厦13楼东翼		电话: (00852) 25650621	传真: (00852) 28111029
■ 施耐德电气中国研修学院	北京市朝阳区将台路2号和乔丽晶中心施耐德电气大厦	邮编: 100016	电话: (010) 84346699	传真: (010) 84501130

客户支持热线: 400 810 1315

客户支持热线：400 810 1315

施耐德电气中国
Schneider Electric China
www.schneider-electric.cn

北京市朝阳区将台路2号
和乔丽晶中心施耐德电气大厦
邮编: 100016
电话: (010) 8434 6699
传真: (010) 8450 1130

Schneider Electric Building, Chateau Regency,
No.2 Jiangtai Road,Chaoyang District
Beijing 100016, China
Tel: (010) 8434 6699
Fax: (010) 8450 1130

由于标准和材料的变更，文中所述特性和本资料中的图像只有经过我们的业务部门确认以后，才对我们有约束。



本手册采用生态纸印刷